

**Explanation of symbols • Explication des symboles • Explicación de símbolos  
Erläuterung der Symbole • Legenda dei simboli**



**Special instruction** - Please read  
Instructions spéciales - Lire attentivement  
Instrucción especial: Por favor, léala  
Besondere Anweisung - Bitte lesen  
Istruzioni speciali - Leggi attentamente



**Stage complete**  
Etape terminée  
Paso completado  
Schritt abgeschlossen  
Fase completa



**Detail view**  
Vue détaillée  
Visita detallada  
Alternative Ansicht  
Visuale del dettaglio



**Dry fit stage before gluing**  
Tester avant de coller  
Comprobar el encaje antes de pegar  
Positionierung erst ohne Klebstoff ausprobieren  
Prova a secco prima di incollare



**Choice of parts**  
Choix d'éléments  
Modelos de componentes  
Scelta di componenti



**Repeat process**  
Répéter l'étape  
Repetir pasos  
Vorgang wiederholen  
Ripeti il processo



**Do not glue the components**  
Ne pas coller les éléments  
No pegar los componentes  
Bitte die Teile nicht kleben  
Non incollare i componenti



**Rotate part**  
Faire pivoter  
Girar la pieza  
Teil drehen  
Ruota il componente



**READ THIS FIRST:** Before assembling your model kit please read through the instructions in this booklet carefully. A pair of plastic cutters is required to remove the plastic components in this kit from their frame. We advise using a mouldline scraping tool to clean up the parts. To assemble your model you will need plastic glue. Games Workshop sells Citadel Fine Detail Cutters, Citadel Mouldline Remover and Citadel Plastic Glue, but does not recommend these products for use by children under the age of 16 without adult supervision.



**À LIRE EN PREMIER :** Avant de vous lancer dans l'assemblage de ce kit, veuillez lire attentivement les instructions de ce livret. Une pince coupante est requise pour détacher chaque élément de sa grappe. Nous vous recommandons l'utilisation d'un grattoir pour ébarber les éléments. Pour l'assemblage, vous aurez également besoin de colle plastique. Games Workshop commercialise les Pinces de Précision Citadel, l'Ébarboir Citadel et la Colle Plastique Citadel, mais n'en recommande pas l'utilisation pour des enfants de moins de 16 ans sans la supervision d'un adulte.



**LEER ANTES DE MONTAR:** Antes de montar el contenido de este kit, lee estas instrucciones cuidadosamente. Te harán falta unas tenazas para plástico a fin de separar las piezas de la matriz. También aconsejamos una herramienta para rebabas a fin de limpiar cada pieza. Para montar la miniatura necesitarás pegamento para plástico. Games Workshop vende Tenazas Citadel, Herramientas para rebabas Citadel y Pegamento para plástico Citadel, pero no recomendamos estos productos a menores de 16 años sin la supervisión de un adulto.



**LIES DIES ZUERST:** Bitte lies diese Anleitung sorgfältig, bevor du mit dem Zusammenbau deines Modells beginnst. Du benötigst einen Kunststoffseitschneider, um die Kunststoffbauteile aus dem Gussrahmen herauszutrennen, und Kunststoffkleber, um die Miniatur zusammenzubauen. Außerdem empfehlen wir, die Bauteile vorher mit einem Gussgratentferner zu säubern. Games Workshop bietet Präzisions-Kunststoffseitschneider von Citadel sowie Citadel-Kunststoffkleber an, empfiehlt aber, dass Kinder unter 16 Jahren diese nur unter Aufsicht eines Erwachsenen benutzen.



**LEGGI PRIMA QUESTO:** prima di assemblare il tuo modello, leggi le istruzioni di questo libretto con attenzione. Sono necessarie un paio di tronchesine per plastica per staccare i componenti dal loro sprue. Consigliamo di usare un attrezzo apposito per pulire i componenti. Per assemblare il modello avrai bisogno di colla per plastica. Games Workshop vende Tronchesine di precisione Citadel, Attrezzo per ripulire Citadel e Colla per plastica Citadel, ma non consiglia questi prodotti ad un pubblico minore di 16 anni senza la supervisione di un adulto.

16+



- Citadel fine detail cutters
- Pinces de précision Citadel
- Tenazas Citadel
- Citadel-Seitschneider
- Tronchesine di precisione Citadel



- Citadel mouldline remover
- Ébarboir Citadel
- Herramienta para rebabas Citadel
- Gussgratentferner
- Attrezzo per ripulire Citadel

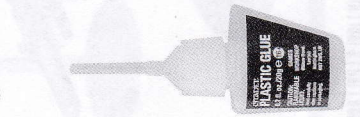

- Citadel plastic glue
- Colle plastica Citadel
- Pegamento para plástico
- Citadel-Kunststoffkleber
- Colla per plastica Citadel



**Follow steps 1-2 for all variants • Suivre les étapes 1-2 pour toutes les variantes • Sigue el paso 1-2 para todas las variantes  
Folge Schritt 1-2 für alle Varianten • Segui le fasi 1-2 per tutte le varianti**

**1 - 2 INTERCHANGEABLE PARTS  
ÉLÉMENTS INTERCHANGEABLES • PARTES INTERCAMBIABLES  
AUSTAUSCHBARE TEILE • COMPONENTI INTERCAMBIABILI**

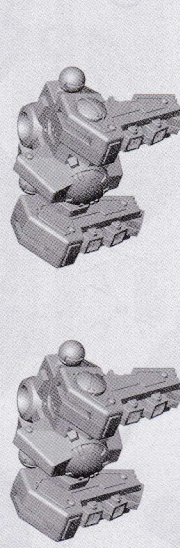
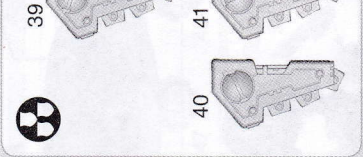
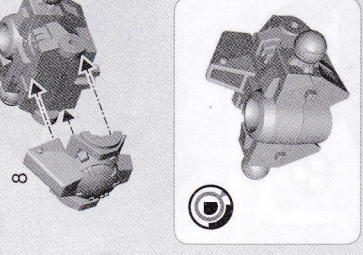
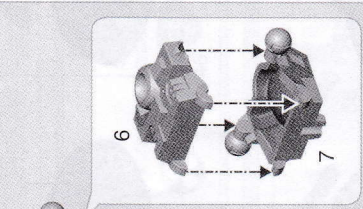
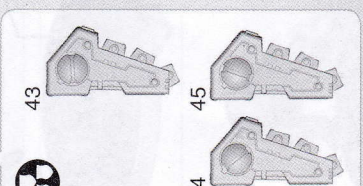
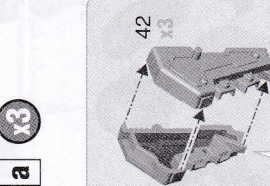

Fusion blaster



Plasma rifle



Flamer



Shield generator



Shield generator

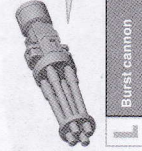

Burst cannon

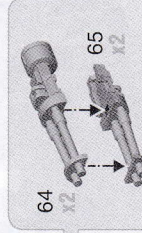

Burst cannon



Burst cannon

**3 x3 XV8 CRISIS BATTLESUITS / XV8 CRISIS BODYGUARD**

**3**

**3 a**

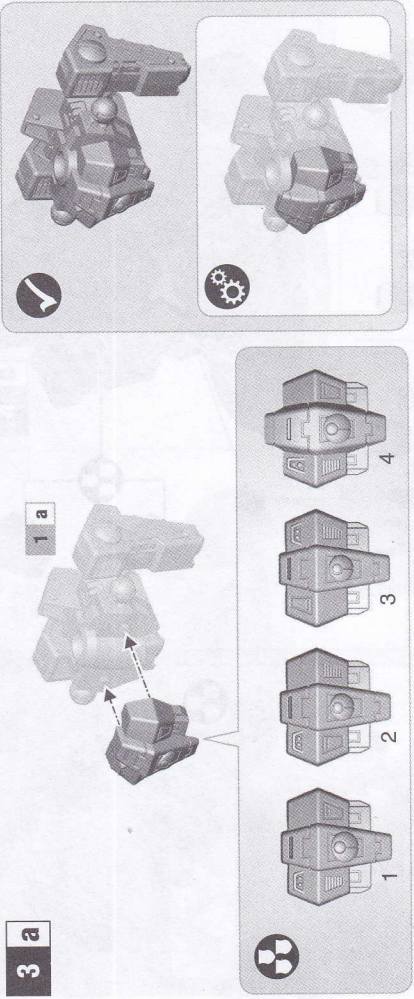

**3 b**

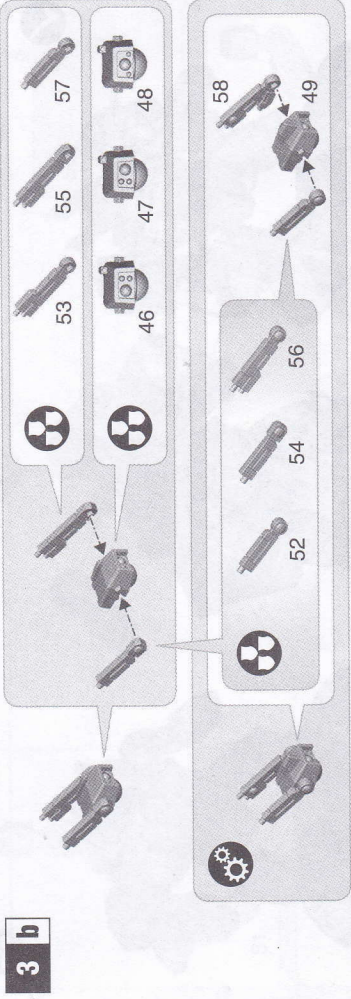

**3 c**

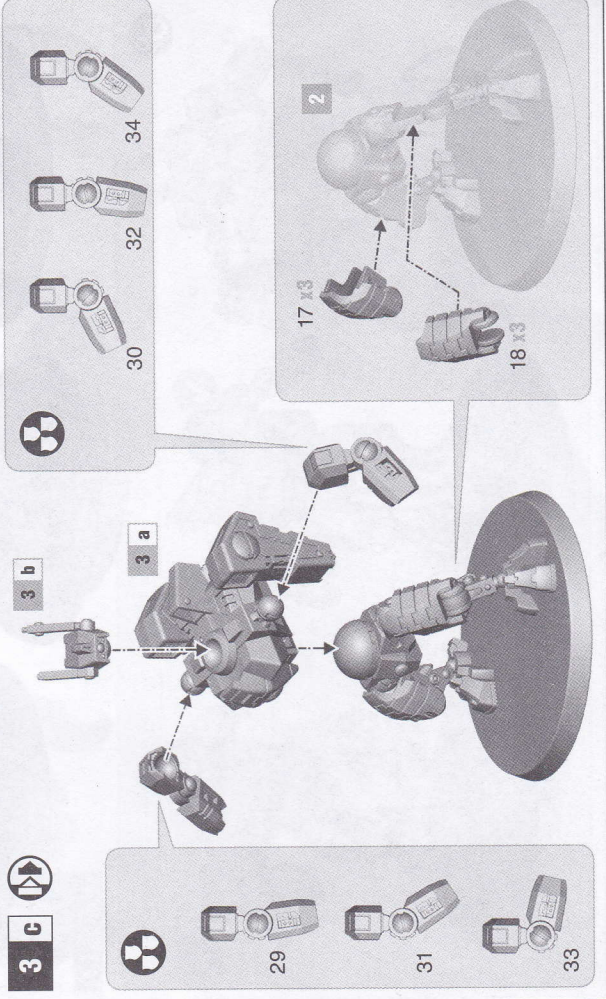

**2**

**x3**

**!**

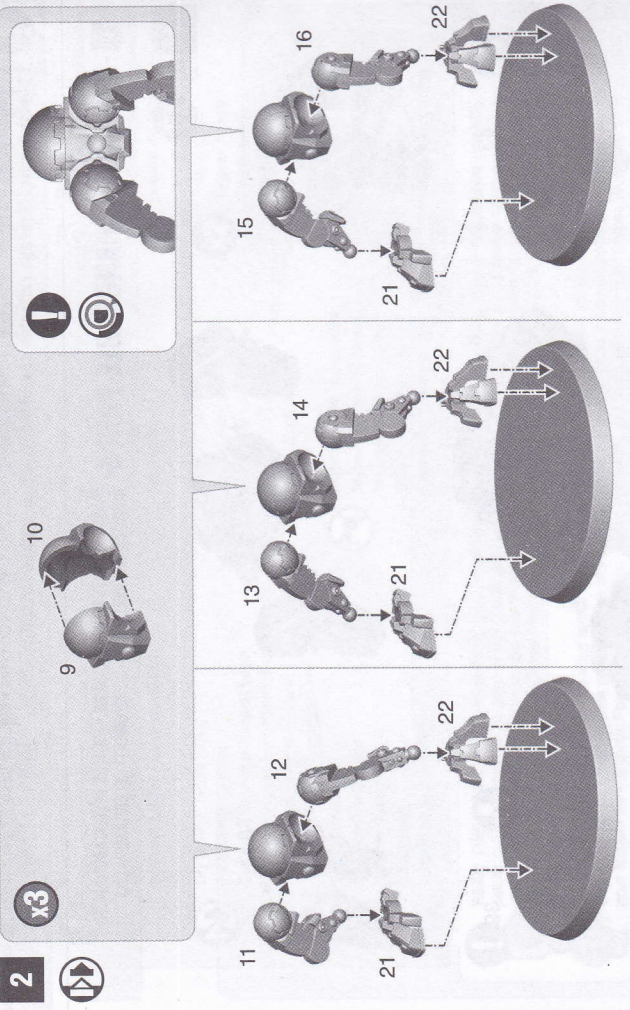

**!**

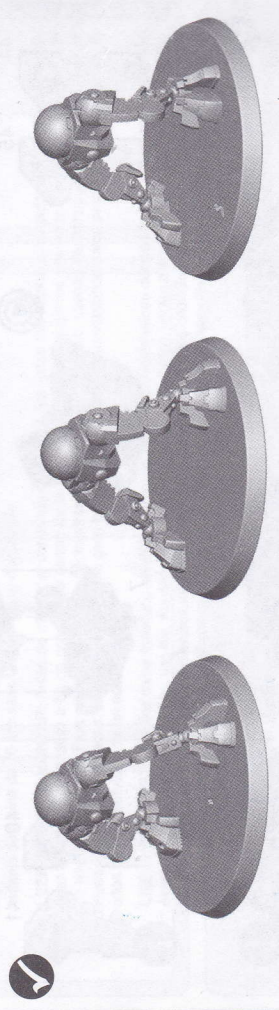

**!**

**!**

**!**

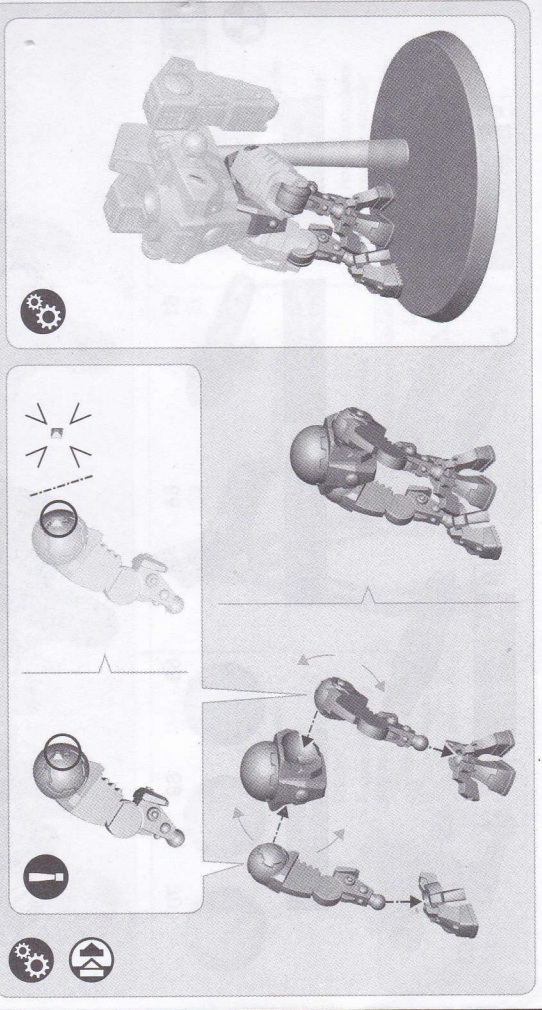

4

x1



4 a

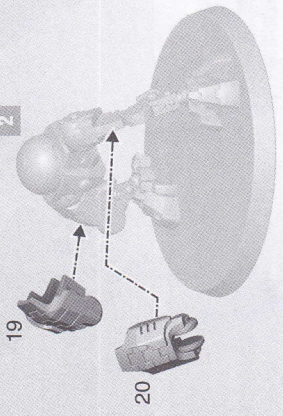

4 b

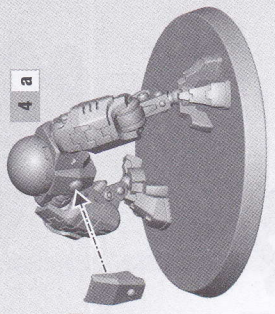

4 c

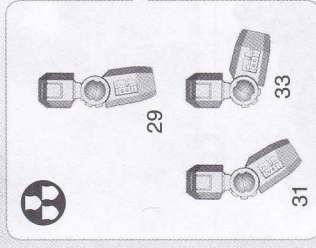

1 a

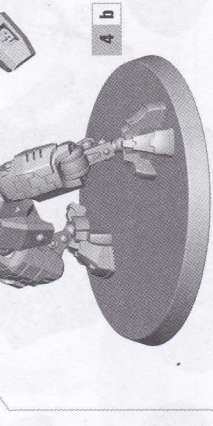

4 b

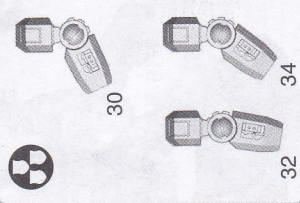
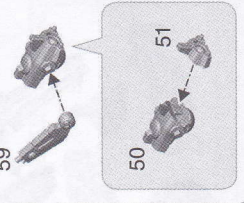

4 d

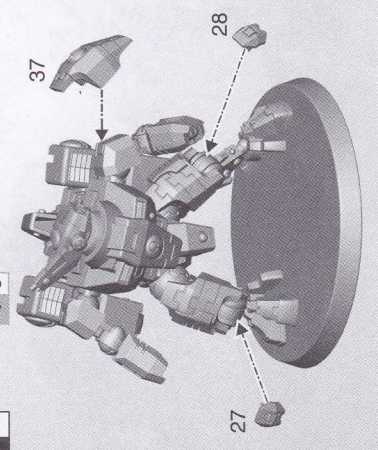

4 c

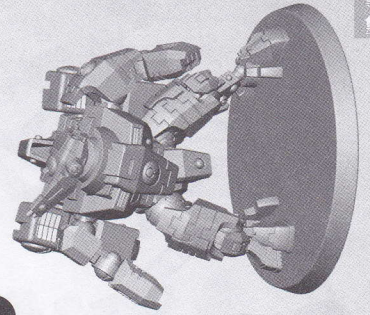

5

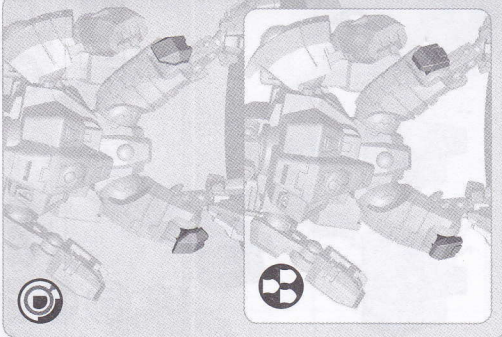

3 c

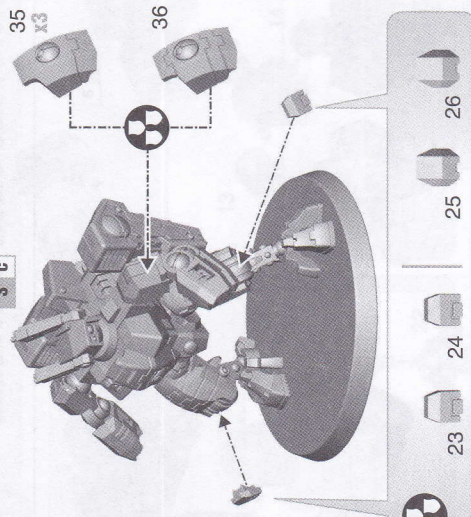

3 d

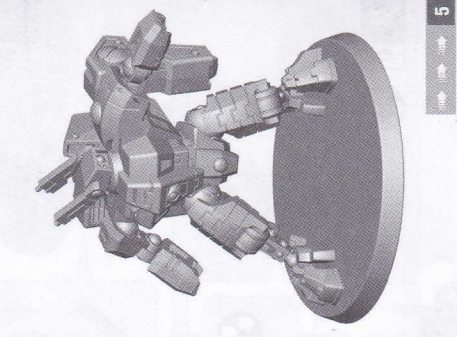
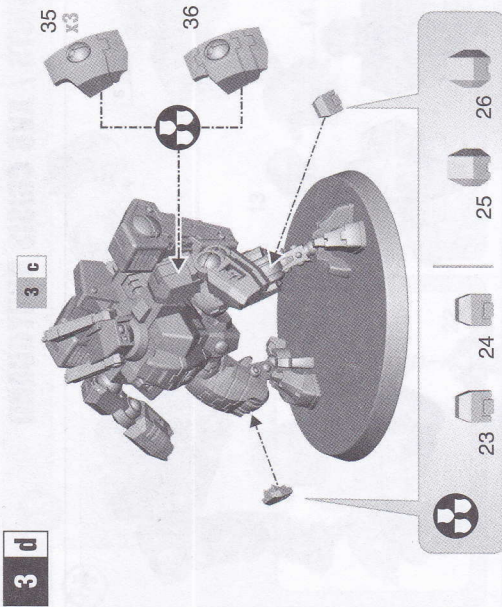

5

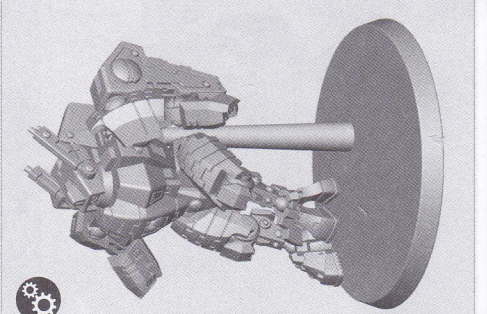
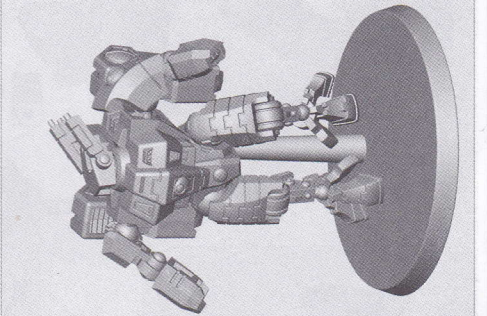
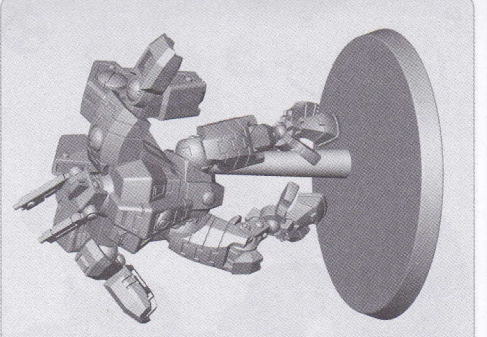
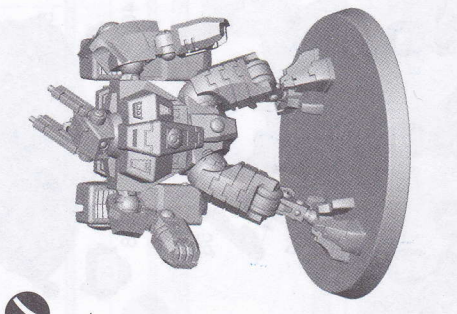
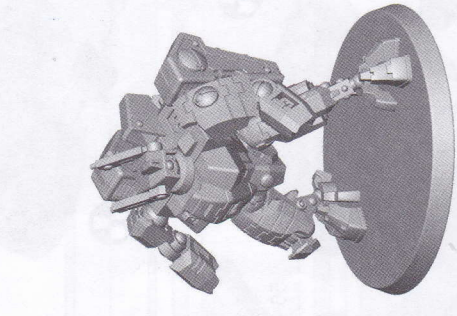

**5** **x3**

**67 x3**

**73**

**74 x2**

**75 x2**

**76**

**77**

**78**

**1 b**

**3 / 4**

**1 b**

**3 / 4**

**6** **x6**

**MV1 Gun Drone**

**MV4 Shield Drone**

**MV7 Marker Drone**

**6** **x6**

**80 x3**

**81 x3**

**82 x3**

**83 x3**

**84 x3**

**85 x3**

**86 x3**

**87 x3**

**88 x3**